

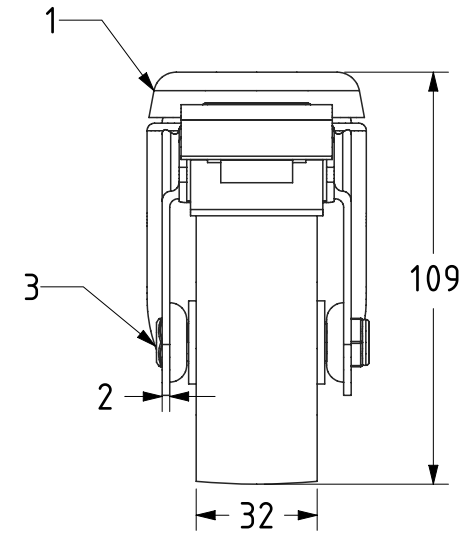

ITEM NO.	PART NUMBER	QTY
1	BZM75ASBH12SWB	1
2	BZM75WPL	1
3	AXLE KIT	
	TUBEM10X37	1
	BOLTBZM8MM	1
	NYLOCM8Z	1



UNLESS OTHERWISE SPECIFIED DIMENSIONS ARE IN MILLIMETRES  Unspecified Tolerances Machining ± 0.25mm Fabrication ± 1mm	DRAWING DISCLAIMER  COPYRIGHT OF THIS DRAWING IS RESERVED BY BIL GROUP LTD. IT IS ISSUED ON CONDITION THAT IT IS NOT REPRODUCED, COPIED, OR DISCLOSED TO A THIRD PARTY EITHER WHOLLY OR IN PART WITHOUT THE CONSENT IN WRITING OF BIL GROUP LTD.		NAME	DATE		BIL Group Ltd, Porte Marsh Road, Calne, Wiltshire, SN11 9BW, United Kingdom Tel +44 (0)1249 822 222 www.bilgroup.co.uk	
		DRAWN	Matt	02/06/23			
		APPROVED BY	Kevin	02/06/23	DWG NO.	BZM75PLBH12SWB	REV 1
		SCALE	1:2		BZM75PLBH12SWB		SHEET 1 OF 1
		WEIGHT	0.44kg				