

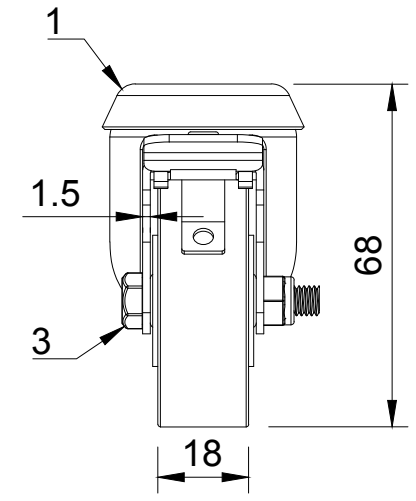

ITEM NO.	PART NUMBER	QTY
1	BZD50ASBH10SWB	1
2	BZL50WVGRBJM6	1
3	AXLE KIT	
	HEXBOLTM6X35Z8.8	1
	NYLOCM6Z	1



UNLESS OTHERWISE SPECIFIED DIMENSIONS ARE IN MILLIMETRES Unspecified Tolerances Machining ± 0.25mm Fabrication ± 1mm	DRAWING DISCLAIMER COPYRIGHT OF THIS DRAWING IS RESERVED BY BIL GROUP LTD. IT IS NOT REPRODUCED, COPIED, OR DISCLOSED TO A THIRD PARTY EITHER WHOLLY OR IN PART WITHOUT THE CONSENT IN WRITING OF BIL GROUP LTD	NAME	DATE	 BIL Group Ltd Porte Marsh Road Calne, Wiltshire, SN11 9BW United Kingdom Tel +44 (0)1249 822 222 www.bilgroup.co.uk	 VARLEY H Varley Ltd Unit 5 Century Park Pacific Rd, Broadheath, Altrincham, Cheshire WA14 5BJ Tel +44 (0)161 928 9617 www.varley-castors.co.uk	
		DRAWN BY	Matt			31/03/25
		APPROVED BY	Kevin			01/04/25
		SCALE	2:3			
		WEIGHT	0.171kg			
DWG NO.			BZD50VGRBJBH10SWB	REV	1	
			BZD50VGRBJBH10SWB	SHEET 1 OF 1		