

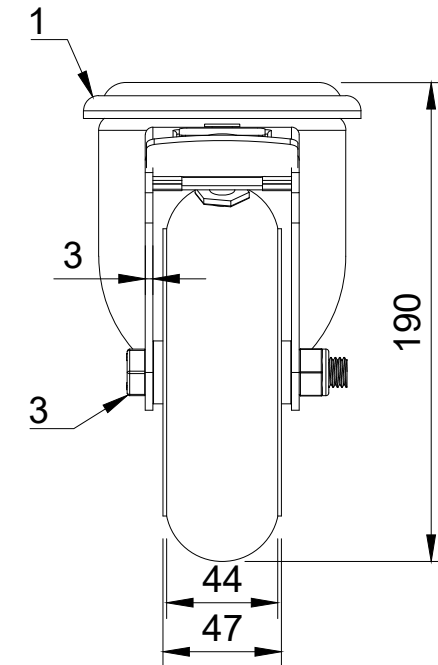

ITEM NO.	PART NUMBER	QTY
1	BZMM150ASBH12SWB	1
2	BZH150WSRERBJM20	1
3	AXLE KIT	
	TH20X5X12	2
	HEXBOLTM12X80Z8.8	1
	NYLOCM12Z	1



UNLESS OTHERWISE SPECIFIED DIMENSIONS ARE IN MILLIMETRES Unspecified Tolerances Machining ± 0.25mm Fabrication ± 1mm	DRAWING DISCLAIMER COPYRIGHT OF THIS DRAWING IS RESERVED BY BIL GROUP LTD. IT IS NOT REPRODUCED, COPIED, OR DISCLOSED TO A THIRD PARTY EITHER WHOLLY OR IN PART WITHOUT THE CONSENT IN WRITING OF BIL GROUP LTD	NAME Matt	DATE 12/11/24	 BIL Group Ltd Porte Marsh Road Calne, Wiltshire, SN11 9BW United Kingdom Tel +44 (0)1249 822 222 www.bilgroup.co.uk	 VARLEY H Varley Ltd Unit 5 Century Park Pacific Rd, Broadheath, Altrincham, Cheshire WA14 5BJ Tel +44 (0)161 928 9617 www.varley-castors.co.uk		
		DRAWN BY Matt	DATE 12/11/24			DWG NO. BZMM150SRERBJBH12SWB	REV 1
		APPROVED BY Kevin	DATE 12/11/24			BZMM150SRERBJBH12SWB SHEET 1 OF 1	
		SCALE 1:3	WEIGHT 2.644kg				