

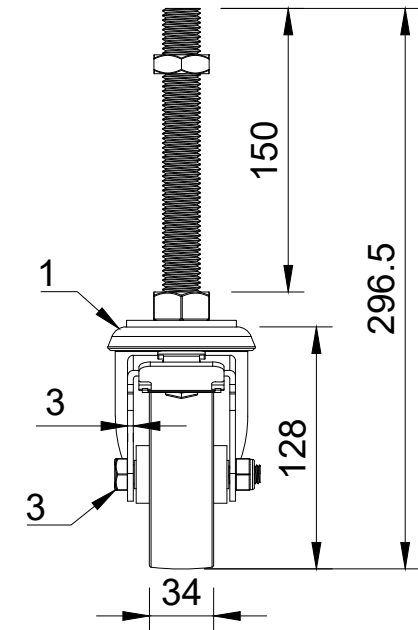

ITEM NO.	PART NUMBER	QTY
1	SSEH100ASBH12SWB	1
2	BZH100WNPRB61	1
3	AXLE KIT	
	TUBEM15X50SS	1
	BOLTM10X70A2	1
	NYLOCM10A2	1
4	STM20X150	1



UNLESS OTHERWISE SPECIFIED DIMENSIONS ARE IN MILLIMETRES Unspecified Tolerances Machining ± 0.25mm Fabrication ± 1mm	DRAWING DISCLAIMER COPYRIGHT OF THIS DRAWING IS RESERVED BY BIL GROUP LTD. IT IS NOT REPRODUCED, COPIED, OR DISCLOSED TO A THIRD PARTY EITHER WHOLLY OR IN PART WITHOUT THE CONSENT IN WRITING OF BIL GROUP LTD		NAME	DATE	 BIL Group Ltd Porte Marsh Road Calne, Wiltshire, SN11 9BW United Kingdom Tel +44 (0)1249 822 222 www.bilgroup.co.uk	 H Varley Ltd Unit 5 Century Park Pacific Rd, Broadheath, Altrincham, Cheshire WA14 5BJ Tel +44 (0)161 928 9617 www.varley-castors.co.uk
		DRAWN BY	Matt	17/10/24		
		APPROVED BY	Kevin	17/10/24		
		SCALE	1:3			
		WEIGHT	1.553kg			
DWG NO. SSEH100NPBSWBM20X150					REV	1
SSEH100NPBSWBM20X150					SHEET 1 OF 1	